



EDGE
ELECTRIC POWERHEAD



OWNER'S MANUAL

Review this manual before operating
your EDGE Electric Powerhead

TABLE OF CONTENTS

Subject	Page
<i>Safety Instructions</i>	3
<i>Assembling your Edge Powerhead</i>	4
<i>General Operation</i>	5
Edge Attachments	
<i>Handle Attachments</i>	5
<i>Wand Assembly Attachments</i>	5
Performance Features	
<i>Edge Cleaner</i>	6
<i>Overload Protector</i>	6
<i>Suction Control</i>	6
Maintenance and Care	
<i>Brush Cleaning</i>	7
<i>Belt Removal and Replacement</i>	7
<i>Brush Replacement</i>	8
<i>Replacement Parts</i>	10
<i>Limited Warranty</i>	11
<i>Service Information</i>	11

IMPORTANT SAFETY INSTRUCTIONS

Read all instructions before using this vacuum system.

When using an electrical appliance, basic precautions should always be followed, including the following:

WARNING

To reduce the risk of fire, electrical shock or injury:

- Unplug and disconnect power before servicing.
- Do not use on wet surfaces.
- Do not allow to be used as a toy. Close attention is necessary when used by or near children.
- Use only as directed in this manual. Use only manufacturer's recommended attachments.
- Do not use with damaged cord or plug. If appliance is not working as it should, has been dropped, damaged or exposed to water, return it to a service center.
- Do not pull or carry by cord, use cord as a handle, close a door on cord, or pull cord around sharp objects or corners. Do not run appliance over cord. Keep cord away from heated surfaces.
- Do not unplug by pulling on cord. To unplug, grasp the plug, not the cord.
- Do not handle system or appliance with wet hands.
- Do not put any object into openings.
- Do not use with any opening blocked; keep free of dust, lint, hair, and anything that may reduce airflow.
- Keep hair, loose clothing, fingers, and all parts of body away from openings and moving parts.
- Do not pick up anything that is burning or smoking, such as cigarettes, matches, or hot ashes.
- Turn off all controls before unplugging.
- Use extra care when cleaning on stairs.
- Do not pick up flammable or combustible liquids such as gasoline or use it in any areas where they may be present.
- The hose contains electrical wires. Do not use if damaged, cut or punctured. Avoid picking up sharp objects.
- Always turn off this appliance before connecting or disconnecting either hose or motorized nozzle.

SAVE THESE INSTRUCTIONS

Intended for Household Use Only

ASSEMBLING YOUR EDGE POWERHEAD

Before assembling your Edge Electric Powerhead for the first use, be sure you have all parts.

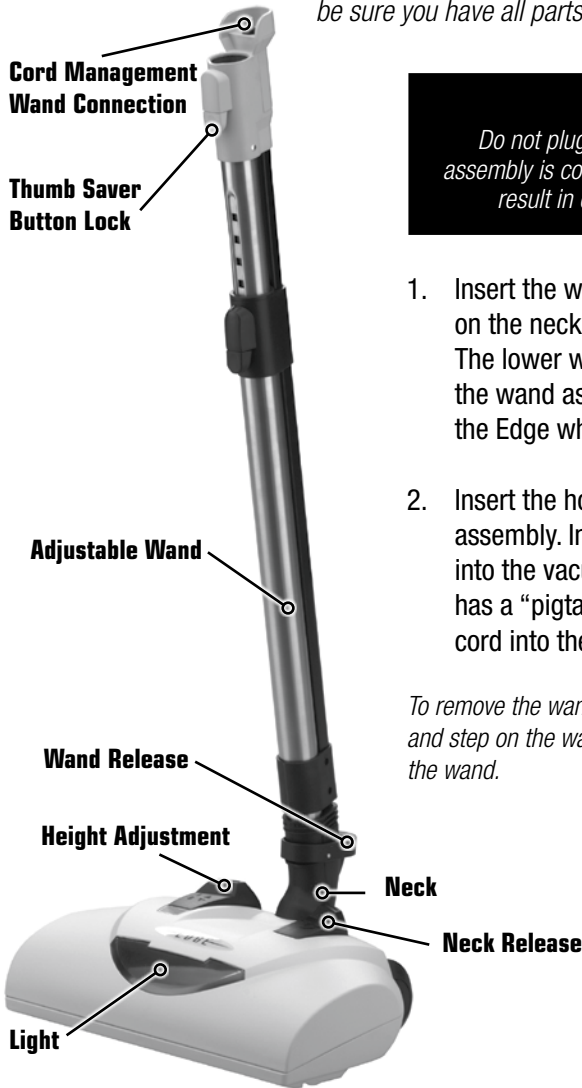

WARNING:

Do not plug into electrical supply until assembly is complete. Failure to do so could result in electrical shock or injury.

1. Insert the wand into the opening located on the neck of the electric powerhead. The lower wand button lock will prevent the wand assembly from detaching from the Edge while in use.
2. Insert the hose handle into the wand assembly. Insert the hose wall adapter into the vacuum inlet valve. If your hose has a “pigtail”, plug the 120V power cord into the nearest electrical outlet.

To remove the wand, disconnect the power cord and step on the wand release pedal, then pull up on the wand.

WARNING

Always unplug the Edge before cleaning the brush area as brush may suddenly restart. Failure to do so can result in personal injury.

GENERAL OPERATION



The Edge is controlled by pressing the three position on/off power control switch located on the hose handle. When the switch is pushed to the left (I) it turns on the vacuum only. When the switch is pushed to the right (II) it operates both the vacuum and the brush roller. The headlight will operate when the Edge is turned on.



The powerhead has a height adjustment pedal for various carpet heights. Use the low setting (#1) for short napped carpets and the highest setting (#5) for plush carpets. To change the height of the Edge, simply, apply pressure to the height adjustment pedal with your toe.

EDGE ATTACHMENTS

Hose Handle Attachments - using the hose with other attachments

If the Edge is attached to the wand, turn cleaner OFF before removing hose handle from the wand.

To disconnect the hose from the wand:

1. Press the gray “thumb-saver” lock button, then pull on the handle to disconnect from the wand.
2. Slide attachments firmly on handle as needed.

Wand Assembly Attachments

To remove the powerhead from the wand:

1. Lock wand in the straight up position.
2. Press easy release pedal with foot, located on the left side, and pull the wand straight up out of the Edge.
3. Put desired attachments on wand as needed.



CAUTION

*Do not attach or remove handle or wands while cleaner is ON.
This could cause sparking and damage the electrical contacts.*

PERFORMANCE FEATURES

Edge Cleaner

The Edge has built-in **channels** on both sides that allow dirt and debris to flow in from the edges freely. Vacuuming close to baseboards and furniture will capture dirt trapped at carpet edges.

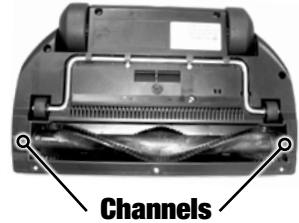

Overload Protector

The Edge has built-in protection against motor and belt damage should an obstruction cause the roller brush to suddenly stop. The overload protector will activate when the powerhead consumes more power than planned or an obstruction makes the brush hard to turn. If this occurs:

- Turn off the vacuum and remove hose handle from the wand.
- Remove the object that is preventing the brush from rotating.
- 30 - 60 seconds of cool-down time may be required for the circuit breaker to automatically reset.
- Reconnect the hose handle to the powerhead and proceed to clean.

Suction Control

The suction control allows you to easily change the vacuum suction for different fabric and carpet weights. Opening the control decreases suction for drapes and lightweight rugs, while closing the control increases suction for upholsteries and carpets.

Handle Release Pedal

The handle release pedal allows you to lower the wand and handle for extended and easier reach under furniture.



MAINTENANCE AND CARE

WARNING:

Always unplug electrical cord and vacuum hose before servicing and maintaining the Edge Electric Powerhead. Failure to do so could result in electrical shock or personal injury from cleaner suddenly starting. Always follow all safety precautions specified when caring for your Edge.

Brush Cleaning

Check the brush roll and brush support areas frequently in order to maintain optimum efficiency. If hair, string, thread, carpet fiber or lint becomes wound around the brush roll, remove by unwinding them by hand or carefully cutting with scissors. If buildup becomes excessive, disconnect the EDGE Powerhead from the wand assembly and follow the Brush Replacement steps on page 8. Instructions can also be found under the light cover.

Belt Removal and Replacement

The belt should also be checked periodically to be sure it is in good condition. It should be replaced if it is stretched, cracked or broken. If the belt needs replaced, use only Edge Belt #9204-01.

To remove belt:

1. Remove cover

- Depress Neck Release Pedal and remove (8) #10 Torx screws, set aside for reassembly. **Note:** 3 longer screws are in front of the brush roller.
- Turn Edge right side up and lift cover making sure pedals stay secure in cover housing.

2. Remove secondary cover

- Remove clear plastic neck release lever and return spring-set aside.
- Remove 3 #10 Torx screws and set aside
- Lift secondary cover and slide by wiring harness.

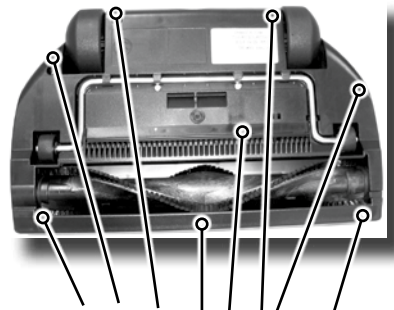

Remove 8 Torx Screws

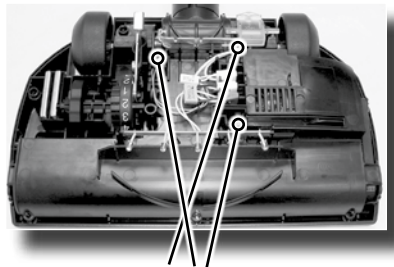

Remove 3 Torx Screws

MAINTENANCE AND CARE

3. Remove Brush Roller Assembly

- Lift Roller Assembly while guiding end cap past belt.

4. Remove Belt

- Guide belt past drive gear on motor.

5. Replace Belt

- Only use Edge Belt # 9204-01.
- Guide new belt over gear on motor.
- Guide new belt over end cap of brush roll.

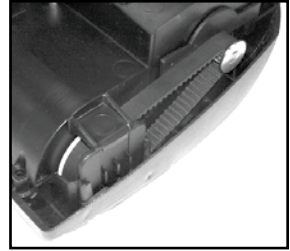

6. Replace Brush Roller

- Place brush roller assembly with belt over gear into base assembly. Note: Narrow side of end cap faces down.

7. Reverse steps above to reassemble the powerhead

- Make certain all wires are in their original positions.
- Take care when placing the neck assembly into its original position. The 2 yellow wires from the neck must move freely through the 'gate' under the neck axis pivot. Be certain wires do not become "pinched."

Changing the Brush Roller

Depending on usage and flooring type the brush will become worn and will need to be replaced.

*****Only replace the complete brush assembly (brush, axles, bearings, end caps, part #9193).***

To remove roller brush

1. Remove Cover

- Depress Neck Release Pedal and remove (8) #10 Torx screws, set aside for reassembly. Note: 3 longer screws are in front of the brush roller.

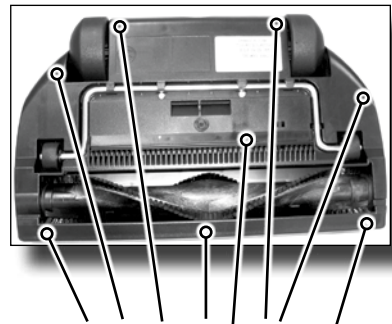

Remove 8 Torx Screws

MAINTENANCE AND CARE

- Turn Edge right side up and lift cover making sure pedals stay secure in cover housing.

2. Remove secondary cover

- Remove clear plastic neck release lever and return spring-set aside.
- Remove 3 #10 Torx screws and set aside.
- Lift secondary cover slide by wiring harness-set aside.

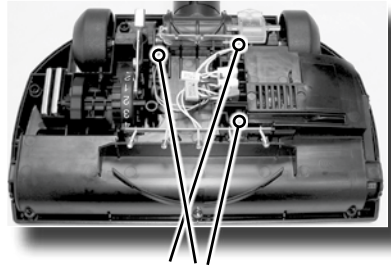

Remove 3 Torx Screws

3. Remove Brush Roller Assembly

- Lift Roller Assembly while guiding end cap past belt.

4. Replace Brush Roller

- Only use part #9193.
- Place brush roller assembly with belt over gear into base assembly.

Note: Narrow side of end cap faces down.

5. Reverse Steps above to reassemble the powerhead

- Make certain all wires are in their original positions.
- Take care when placing the neck assembly into its original position. The 2 yellow wires from the neck must move freely through the 'gate' under the neck axis pivot. Be certain wires do not become "pinched."

EDGE REPLACEMENT PARTS

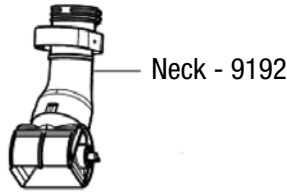

Neck - 9192

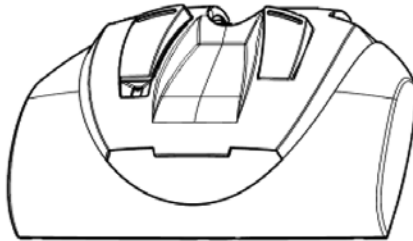

Cover - 9191

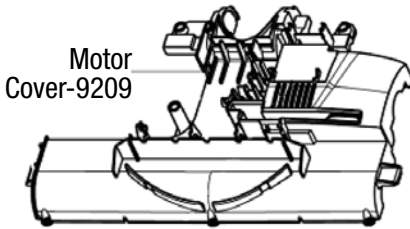

Motor
Cover-9209



Wire Coupler - 9198



Noise Reducer - 9199



Circuit Protector - 9200

Height Adjustment
Assembly - 9194



LED Light Bar - 9201

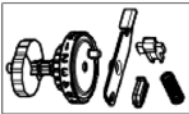

Long Screw-9211

Short
Screw - 9210



Brush
Roll - 9193

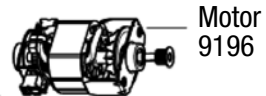
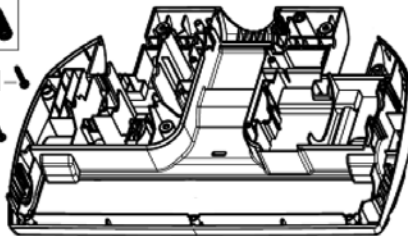

Motor
9196

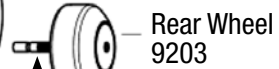

Rear Wheel
9203

Rear Wheel Axle - 9202



Belt - 9204-01

Front Wheels
w/ Stirrup - 9197



LIMITED WARRANTY

H-P Products, Inc. warrants that the Edge Electric Powerhead, when used for household purposes, pursuant to Seller's instructions, will be free from defects in materials and workmanship for a period of one (1) year from the date of the initial consumer purchase. H-P Products, Inc. warrants that the Edge Electric Powerhead, when used in a commercial application, pursuant to Seller's instructions will be free from defects in materials and workmanship for a period of ninety (90) days from the date of initial sale by H-P Products, Inc. This warranty does not cover consumable parts such as light bulbs and replacement belts. This warranty is limited to the replacement of defective parts and any costs of shipping shall be incurred by the purchaser.

THIS WARRANTY IS EXCLUSIVE AND IS IN LIEU OF ALL OTHER WARRANTIES, EXPRESS, IMPLIED OR STATUTORY AND H-P PRODUCTS, INC. SPECIFICALLY DISCLAIMS RESPONSIBILITY FOR CONSEQUENTIAL AND INCIDENTAL DAMAGES AND LIMITS THE IMPLIED WARRANTY OF MERCHANTABILITY TO THE PERIOD OF EFFECTIVENESS OF THIS EXPRESS WARRANTY.

SERVICE INFORMATION

The instructions in this booklet serve as a guide to routine maintenance. If additional service or repairs are required, please call 1-800-822-8356 for your nearest authorized servicing dealer.



WARNING:

ELECTRIC SHOCK COULD OCCUR IF USED ON WET SURFACES



H-P Products
Central Vacuums

512 W. Gorgas Street
Louisville, Ohio 44641-0912
www.CentralVacService.com